

DURAMAX®
DryMax®
 SHAFT SEAL SYSTEMS

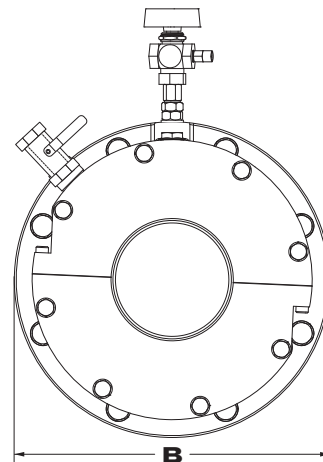
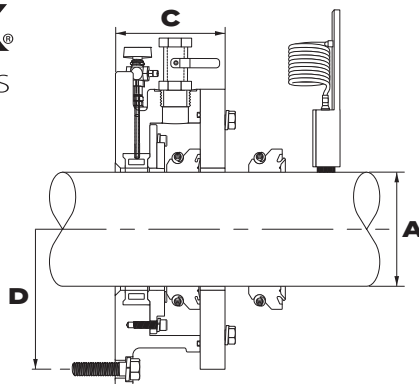

Information Required To Quote:

SEAL SPACE REQUIREMENTS								
Model	A Shaft Size (in or mm)	B Flange OD (in)	B Flange OD (mm)	C Length (in)	C Length (mm)	D BCD (in)	D BCD (mm)	Bolt (in)

Type Shaft Size (between 3.5 - 36.49 inch or 89 - 927 mm) – select inch or mm – Click OK

Customer Information:

Name: _____

Company: _____

Address: _____

City: _____ State: _____ Zip: _____

Country: _____

Email: _____

Phone: _____

Vessel Information:

1. Vessel Name: _____

2. Vessel *IMO# / Hull#: _____

3. Shaft Diameter: _____

4. Hull Material: _____

5. Quantity: _____

6. New Construction/Retro-fit: _____

7. Serial Number (existing seal): _____

8. Original Installation Date: _____

9. Original Installation Yard: _____

10. Shipyard Name: _____

Information for DryMax Seal Retrofit Installation:

1. Adapter Plate Required: YES NO

2. Existing BCD (bolt circle diameter): _____

3. Existing Number of Bolts: _____

Notes:

*(IMO) - International Maritime Number



FORWARD TOGETHER.